

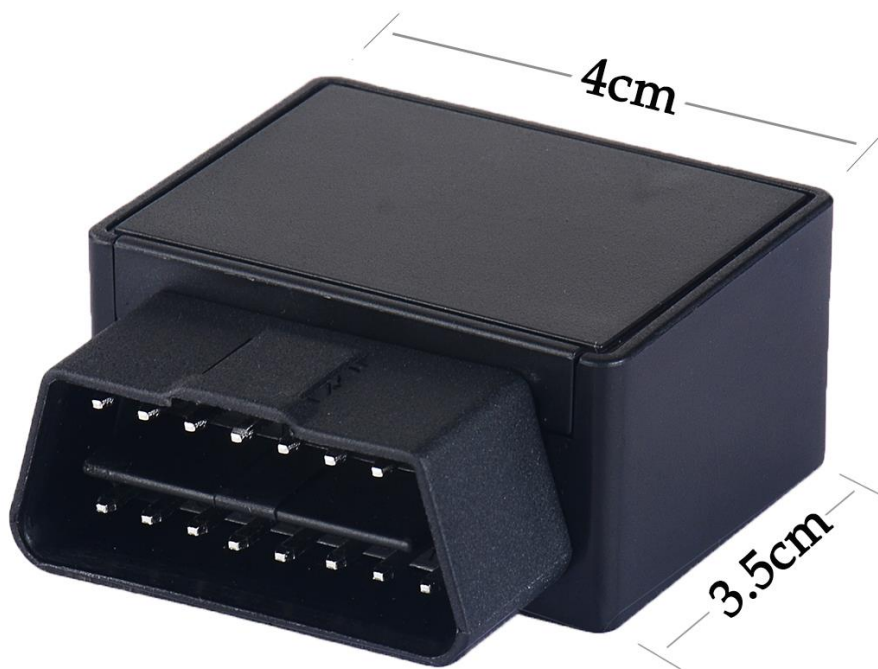

GPS Tracker ST-902

User Manual



How to install:

It is plug and play device, connect it to OBD connector is ok.

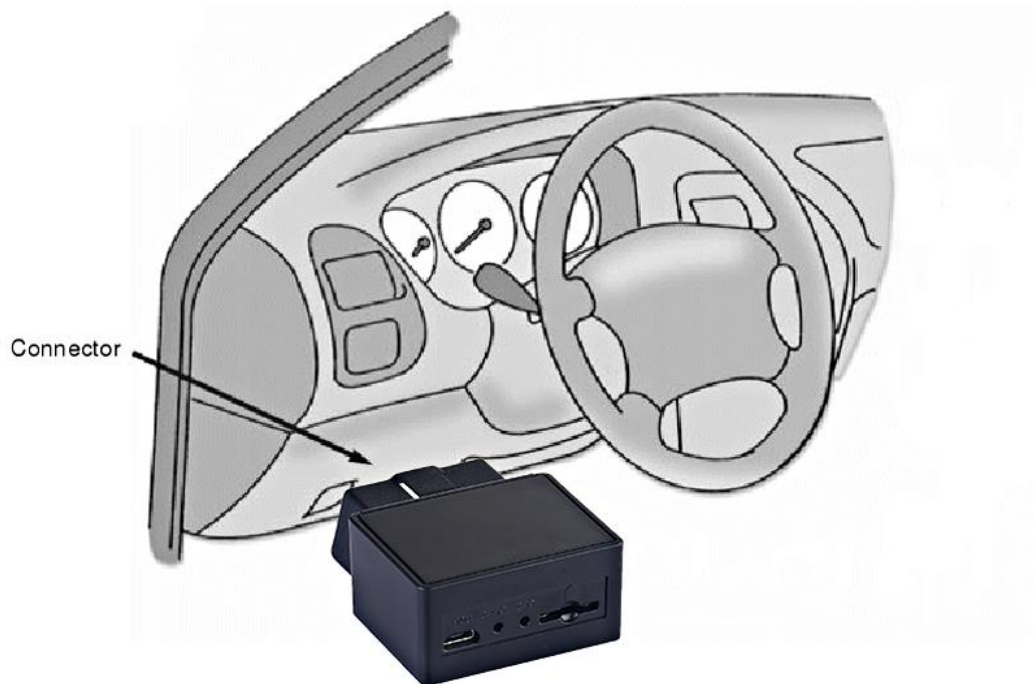

How to find the OBD connector on your car:

There are 6 places you may find the connector (most of car in the 1 place)

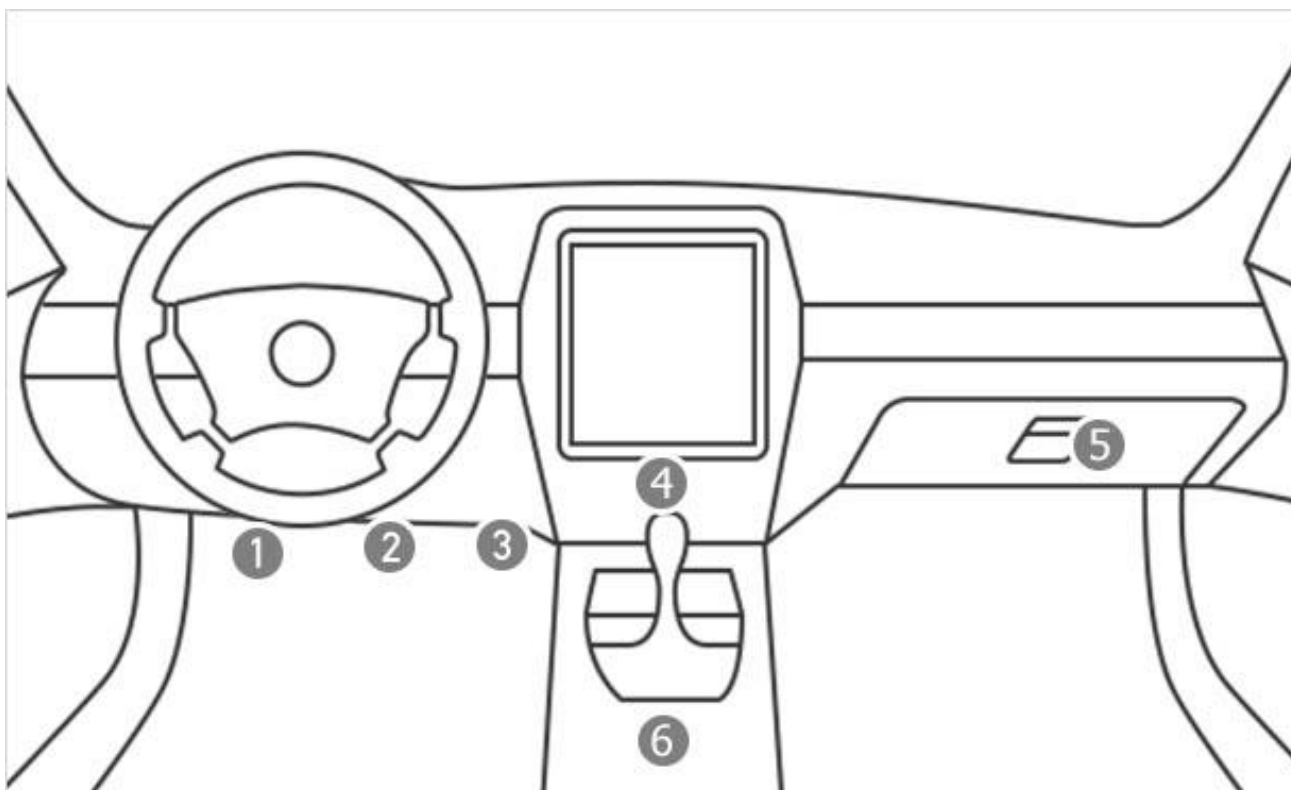

LED Status

1.1. Blue LED--- GPS Status

Status	Meaning
Flashing	No GPS Signal or GPS starting
ON	GPS OK

1.2. Orange LED---GSM Status

Status	Meaning
Flashing	No SIM card or GSM starting
ON	GSM OK

The default password is: 0000

The default mode is normal working (sleep off).

GPS Status: A is get location, V is invalid location.

Alarm mode is on.

Alarm will send to the 3 control number.

Battery 5 is 100%, 1 is 20%; the battery is from 1 to 5.

Functions:

1. Set control number:

Command: **Number+pass+blank+serial**

Sample: **139504434650000 1**

13950443465 is mobile number, 0000 is password, 1 is serial means the first number.

When the tracker reply "SET OK" means the setting is ok.

You can set the second and third control number also.

2. Working mode:

ST-902 has both SMS and GPRS working mode.

1. If you want to control it by mobile and use SMS only, you can get Google location from you mobile, then you can choose SMS mode.

2. If you want to monitor the tracker online real time, and you want to install the tracker data for years, you should choose the GPRS mode.

You can send SMS to choose the mode.

SMS Mode: (Default)

Command: **700+Password**

Sample: **7000000**

Reply: SET OK

When ST-902 receives the command, it will change to SMS mode.

GPRS Mode:

Command: **710+Password**

Sample: **7100000**

Reply: SET OK

When ST-902 receives the command, it will change to GPRS mode.

3. Change Password

Command: **777+New Password+Old password**

Sample: **77712340000**

The 1234 is new password, and 0000 is old password.

When ST-902 received the command, it will reply SET OK

4. Get location with Google link

Command: **669+password**

Sample: **6690000**

When ST-902 receives the command, it will read the GPS data, and send back the location with Google link; You can open the link to check the tracker location on maps.

6690000

[http://maps.google.com/maps?q=+22.64208,+114.18828](http://maps.google.com/maps?q=) Date:
2016-5-18 Time:13:40 ID:
8160528336 Fix:A Speed:0KM/H Bat:
5

5. Get location by phone call.

You can use any mobile to call the SIM Card in tracker, it will reply the location with Google link; you can open the link to check the tracker location on maps.

[http://maps.google.com/maps?q="+22.64207,+114.18829](http://maps.google.com/maps?q=) Date:
2016-5-18 Time:13:36 ID:
8160528336 STATE:Phone ACC OFF
Fix:A Speed:0KM/H Bat:5

When you call the tracker when it is in invalid location, it will reply the last valid location to you, after it get new location again, it will send the seconds SMS to you with new location.

6. Change Time Zone

Command: **896+password+Blank+E/W+HH**

Sample: **8960000E00 (default)**

E means East, W means west, 00 mean time zone.

Reply: SET OK

0 time zone is 8960000 00

7. Send location in defined time every day.

It will send to the first control number.

Command: **665+password+HHMM**

HH mean hour, it from 00 to 23,
MM means minutes, it from 00 to 59.

Sample: **66500001219**

Reply: SET OK

Close the function command: **665+password+OFF (default)**

Sample: **6650000OFF**

Reply: SET OK

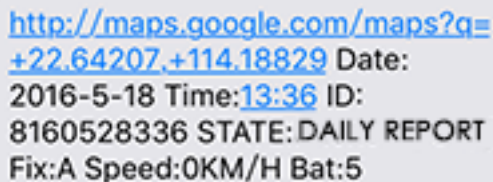

[http://maps.google.com/maps?q=
+22.64207,+114.18829](http://maps.google.com/maps?q=) Date:
2016-5-18 Time:13:36 ID:
8160528336 STATE: DAILY REPORT
Fix:A Speed:0KM/H Bat:5

8. Geo Fence (send alarm to the first number only)

Open Geo Fence: **211+password**

Sample: **2110000**

Reply: SET OK

Close Geo Fence: **210+password**

Sample: **2100000**

Reply: SET OK

Set the Geo Fence

Sample: **0050000 1000 (the Geo Fence is 1000 meters)**

Reply SET OK

We suggest the Geo Fence more than 1000 meters.

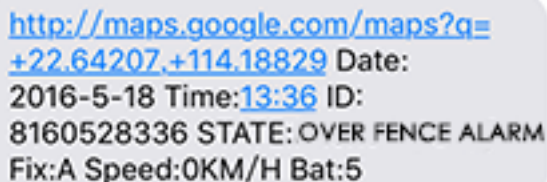

[http://maps.google.com/maps?q=
+22.64207,+114.18829](http://maps.google.com/maps?q=) Date:
2016-5-18 Time:13:36 ID:
8160528336 STATE: OVER FENCE ALARM
Fix:A Speed:0KM/H Bat:5

9. Over speed Alarm (send Alarm to control numbers)

Command: **122+Blank+XXX**

Sample: **1220000 120**

Reply: SET OK

The XXX is the speed, from 0 to 999, the unit is KM/H.

If the XXX is 0, it means close the over speed alarm.

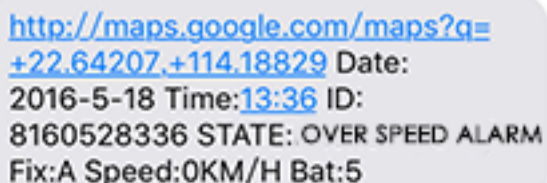

[http://maps.google.com/maps?q=
+22.64207,+114.18829](http://maps.google.com/maps?q=) Date:
2016-5-18 Time:13:36 ID:
8160528336 STATE: OVER SPEED ALARM
Fix:A Speed:0KM/H Bat:5

10. Mileage

Set the initial Mileage

Command: **142+Password<+M+X>**

X is the initial Mileage, the unit is meter.

Sample: **1420000**

Reply: MILEAGE RESET OK

Sample: **1420000M1000**

Reply: SET OK, CURRENT: 1000

Red the current Mileage

Command: **143+password**

Sample: **1430000**

Reply: CURRENT TOTAL MILEAGE:XX.

XX is the mileage, the unit is meter.

11. Shock Alarm (send SMS alarm to the first number)

Open Shock Alarm: **181+password+T**

Sample: **1810000T10**

Reply: SET OK

The T meaning shocking time, the unit is second,

It from 0 to 120 seconds.

Close Shock Alarm: **180+password**

Sample: **1800000**

Reply: SET OK

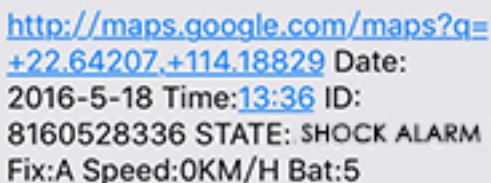

[http://maps.google.com/maps?q=+22.64207,+114.18829](http://maps.google.com/maps?q=) Date:
2016-5-18 Time:13:36 ID:
8160528336 STATE: SHOCK ALARM
Fix:A Speed:0KM/H Bat:5

12. Low battery alarm (send SMS to first number)

When the battery is low, the tracker will send the Low Power Alarm SMS to the first number

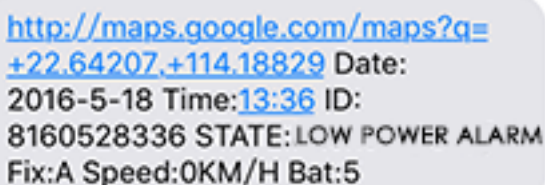

[http://maps.google.com/maps?q="+22.64207,+114.18829](http://maps.google.com/maps?q=) Date:
2016-5-18 Time:13:36 ID:
8160528336 STATE: LOW POWER ALARM
Fix:A Speed:0KM/H Bat:5

When the battery is Full, Bat:5, means 100%; Bat:4 means 80%, Bat:3 means 60%, Bat:2 means 40%, Bat:1 means 20%. When the Bat is 1, it will send low battery alarm.

13. Call mode

Call mode on:

Command: **150+password**

Sample: **1500000**

Reply: SET OK

Call mode off

Command: **151+password**

Sample: **1510000**

Reply: SET OK

When the call mode on, the alarms will call and send SMS to control number,

When the call mode off, only send SMS.

14. Sleep mode

Open Sleep mode

Command: **SLEEP0000 1**

Reply: SET OK

Close Sleep mode

Command: **SLEEP0000 0**

Reply: SET OK

15. Set APN

Command 1: **803+password+Blank+APN**

Sample: **8030000 CMNET**

Reply: SET OK

If your APN need user and pass:

Command 2: **803+password+Blank+ APN+Blank+ APN user+Blank+ APN pass**

Sample: **8030000 CMNET CMNET CMNET**

Reply: SET OK

16. Set the IP and Port

Command: **804+password+Blank+IP+Blank+Port**

Sample: **8040000 103.243.182.54 8090**

Reply: SET OK

17. Set the time interval (default is 20 seconds)

Command: **809+password+Blank+T**

Sample: **8090000 20**

Reply: SET OK

T means the time interval, the unit is second,

It from 0 to 18000 seconds,

When T=0 means close GPRS.

Online Track:

Please login from www.sinotrack.com or <http://103.243.182.54>

You can also down load our APPS on website to track on your mobile:



Other Functions:

1. RESTART

The tracker will restart.

2. RCONF

Read the configure of tracker

Tracker will reply:

AU08, ID: 8160528336, UP:0000, U1:, U2:, U3:, MODE:GPRS

DAILY:OFF, GEO FENCE: OFF, OVER SPEED:OFF

VOICE:ON, SHAKE

ALARM:OFF, SLEEP:OFF, APN:CMNET,,, IP:103.243.182.54:8090, GPRS UPLOAD TIME:20

TIME ZONE:E00

AU08: software version

ID: 8160528336 (Tracker ID)

UP:0000 (password, default is 0000)

U1: the first control number,

U2: the second control number,

U3: the third control number.

MODE:GPRS (working mode, default is GPRS)

DAILY:OFF (Daily time to report, default off)

GEO FENCE: OFF (Geo Fence, default off)

OVER SPEED:OFF (over speed, default off)

VOICE:ON (Call mode, default on)

SHAKE ALARM:OFF (Shock Alarm, default off)

SLEEP MODE : OFF (sleep mode, default off)

APN:CMNET,,, (APN, default is CMNET)

IP:103.243.182.54:8090 (The IP and Port)

GPRS UPLOAD TIME:20 (time interval)

TIME ZONE:E00 (Time zone, default is +0)